

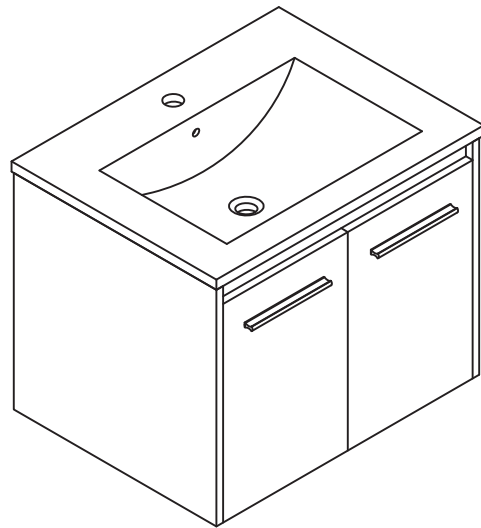

ASSEMBLY INSTRUCTIONS

VF44530MBL / VF44530MGN / VF44530MWT
 VF44530MTK / VF44530MMP / VF44530MWH
 VF44530MCG



Step 1

Wall

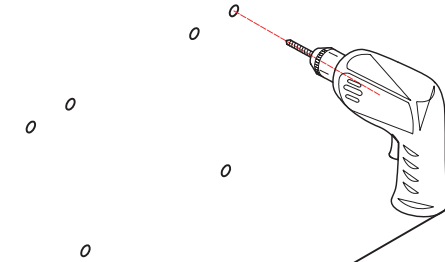

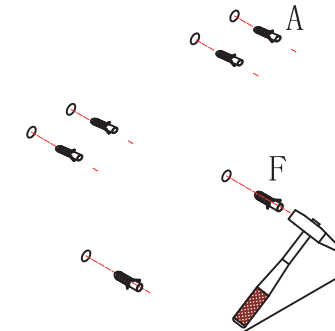

Step 2

Wall



Hardware

NO.	Parts	QTY
A	 (M6*1.18")	4
B		2
C	 (T4*1.38")	4

Tools

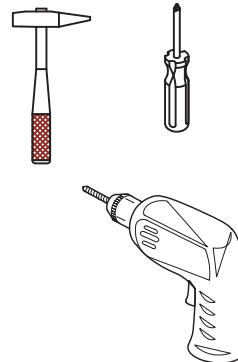

Step 3

Wall

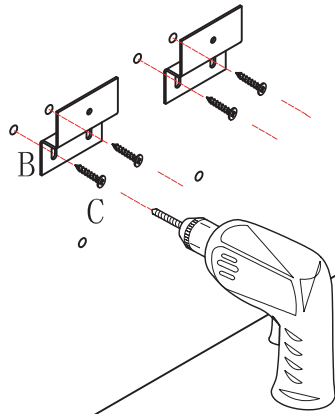

Step 5

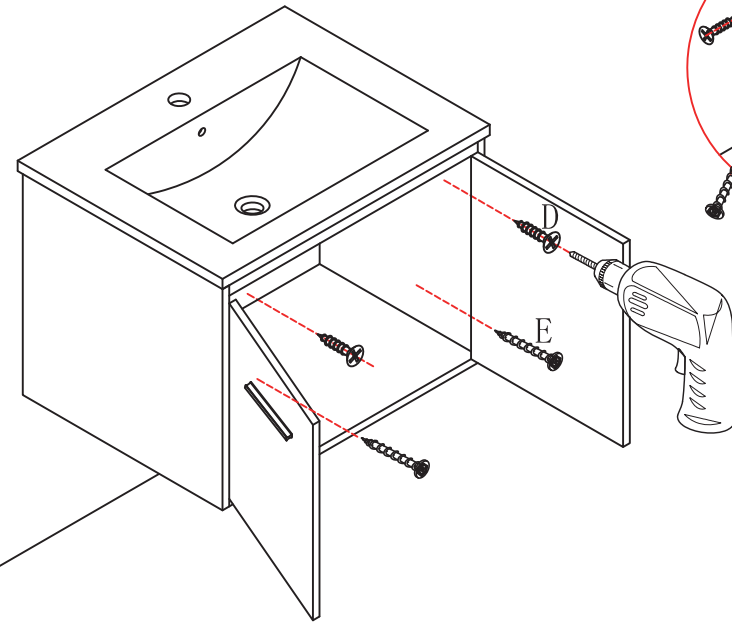

Step 4

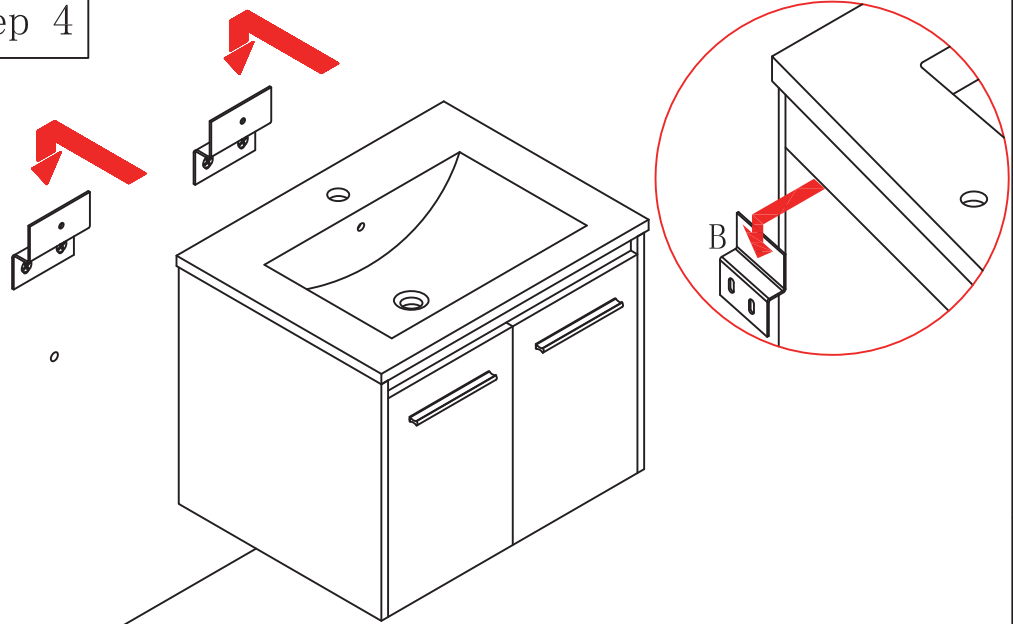

Finished

